

Arbitrary Function Generator Module

AFG-125/225/125P/225P

USER MANUAL

GW INSTEK PART NO. 82DS-23042EA1



ISO-9001 CERTIFIED MANUFACTURER

GW INSTEK

August 2014

This manual contains proprietary information, which is protected by copyright. All rights are reserved. No part of this manual may be photocopied, reproduced or translated to another language without prior written consent of Good Will company.

The information in this manual was correct at the time of printing. However, Good Will continues to improve products and reserves the rights to change specification, equipment, and maintenance procedures at any time without notice.

Good Will Instrument Co., Ltd.
No. 7-1, Jhongsing Rd., Tucheng Dist., New Taipei City 236, Taiwan

Table of Contents

SAFETY INSTRUCTIONS	4
GETTING STARTED	8
AFG-125/225/125P/225P Overview	9
Panel Overview	12
DS2-FH1 Housing Installation	14
Module Installation/Removal	15
USB Configuration	17
AFG App Installation	18
Uninstalling the AFG App	19
QUICK REFERENCE	20
Options Menu Tree	21
OPERATION	25
Basic Operation	26
Modulation	40
Sweep	50
Burst	53
ARB	56
Power Supply Function	70
APPENDIX	71
Dimensions	71
Preset ARB Waveform	72
Declaration of Conformity	80
INDEX	81

S SAFETY INSTRUCTIONS

This chapter contains important safety instructions that should be followed when operating and storing the function generator. Read the following before any operation to ensure your safety and to keep the function generator in the best condition.

Safety Symbols

These safety symbols may appear in this manual or on the instrument.



Warning: Identifies conditions or practices that could result in injury or loss of life.



Caution: Identifies conditions or practices that could result in damage to the function generator or to other objects or property.



DANGER High Voltage



Attention: Refer to the Manual



Protective Conductor Terminal



Earth (Ground) Terminal



DANGER Hot Surface



Double Insulated



Do not dispose electronic equipment as unsorted municipal waste. Please use a separate collection facility or contact the supplier from which this instrument was purchased.

Safety Guidelines

General Guideline



CAUTION

- Do not place heavy objects on the instrument.
- Do not place flammable objects on the instrument.
- Avoid severe impact or rough handling that may damage the function generator.
- Avoid discharges of static electricity on or near the function generator.
- Use only mating connectors, not bare wires, for the terminals.
- The instrument should only be disassembled by a qualified technician.

Power Supply



WARNING

- DC Input voltage: 5V/2A.
- Do not exceed an input voltage of 5V±5%.

Fuse



WARNING

- Fuse type: F3.15A/125V.
 - Only qualified technicians should replace the fuse.
 - To ensure fire protection, replace the fuse only with the specified type and rating.
 - Disconnect the power and all test leads before replacing the fuse.
 - Make sure the cause of fuse blowout is fixed before replacing the fuse.
-

Cleaning the function generator	<ul style="list-style-type: none"> • Disconnect the power cord before cleaning the function generator. • Use a soft cloth dampened in a solution of mild detergent and water. Do not spray any liquid into the function generator. • Do not use chemicals containing harsh products such as benzene, toluene, xylene, and acetone.
---------------------------------	---

Operation Environment	<ul style="list-style-type: none"> • Location: Indoor, no direct sunlight, dust free, almost non-conductive pollution (Note below) and avoid strong magnetic fields. • Relative Humidity: < 80% • Altitude: < 2000m • Temperature: 0°C to 40°C <p>(Pollution Degree) EN 61010-1:2010 specifies pollution degrees and their requirements as follows. The function generator falls under degree 2.</p> <p>Pollution refers to “addition of foreign matter, solid, liquid, or gaseous (ionized gases), that may produce a reduction of dielectric strength or surface resistivity”.</p> <ul style="list-style-type: none"> • Pollution degree 1: No pollution or only dry, non-conductive pollution occurs. The pollution has no influence. • Pollution degree 2: Normally only non-conductive pollution occurs. Occasionally, however, a temporary conductivity caused by condensation must be expected. • Pollution degree 3: Conductive pollution occurs, or dry, non-conductive pollution occurs which becomes conductive due to condensation which is expected. In such conditions, equipment is normally protected against exposure to direct sunlight, precipitation, and full wind pressure, but neither temperature nor humidity is controlled.
-----------------------	--

Storage environment	<ul style="list-style-type: none"> • Location: Indoor • Relative Humidity: < 70% • Temperature: -10°C ~ 70°C
---------------------	--

Disposal

Do not dispose this instrument as unsorted municipal waste. Please use a separate collection facility or contact the supplier from which this instrument was purchased. Please make sure discarded electrical waste is properly recycled to reduce environmental impact.

GETTING STARTED

This chapter gives a brief overview of how to install the AFG-125/225/125P/225P module onto the GDS-2000A.



- AFG-125/225/125P/225P Overview 9**
 - Model Lineup 9
 - Main Features 10
 - Accessories..... 11
 - Optional Accessories 11
- Panel Overview 12**
 - Front Panel 12
 - Rear Panel 13
- DS2-FH1 Housing Installation..... 14**
- Module Installation/Removal 15**
- USB Configuration 17**
- AFG App Installation 18**
- Uninstalling the AFG App..... 19**

AFG-125/225/125P/225P Overview

The AFG-125, AFG-225, AFG-125P and AFG-225P are arbitrary function generator modules for use with the GDS-2000A series DSOs. The options require the DS2-FH1 module extension bay to secure the module to the DSO. This user manual will explain how to become familiar with the arbitrary function generator modules. The Getting Started chapter will introduce the modules with an overview of the features and installation of the APP and accompanying PC software. The Operation chapter will go over the operation details.

Note1: The AFG-125/225/125P/225P are only supported with GDS-2000A series DSOs with firmware version V1.19 or above installed.

Note2: Throughout this manual *AFG-125* will refer to both the AFG-125 and the AFG-125P, unless stated otherwise. Similarly, *AFG-225* will refer to both the AFG-225 and AFG-225P, unless stated otherwise.

Model Lineup

Model	AFG-125	AFG-125P	AFG-225	AFG-225P
Frequency Range	1uHz-25MHz			
Output Channels	1	1	2	2
Power Output	None	Yes	None	Yes

Main Features

- | | |
|--|---|
| Performance | <ul style="list-style-type: none">• DDS signal generator• 1μHz resolution over the full range• 20ppm frequency stability• Arbitrary Waveform Capability<ul style="list-style-type: none">120 MSa/s sample rate60 MSa/s repetition rate4 k-point waveform length4k waveform memory, 10 groupsUser-defined outputDWR (Direct waveform reconstruction) capabilityPC waveform editing |
| Features | <ul style="list-style-type: none">• Sine, Square, Ramp, Pulse & Noise as standard waveforms• Internal LIN/LOG sweeps with marker output• AM, FM, FSK, SUM modulation• Triggered burst function• Save/recall 10 setup memories• Output overload protection |
| Interface | <ul style="list-style-type: none">• USB interface as standard• AWES (arbitrary waveform editing software) PC software |
| Power Supply
(AFG-125P/
225P only) | <ul style="list-style-type: none">• 2.5V/3.3V/5V supply output• 0.6A current output |

Accessories

Part Number	Description
DS2-FH1	Module extension bay
GTL-254	USB A – USB A/B converter
	Quick start guide
	CD User manual

Optional Accessories

Part Number	Description
GPA-501	Power adapter
GTL-246	USB Type A – Type B cable
GTL-201A	Ground lead

Panel Overview

Front Panel

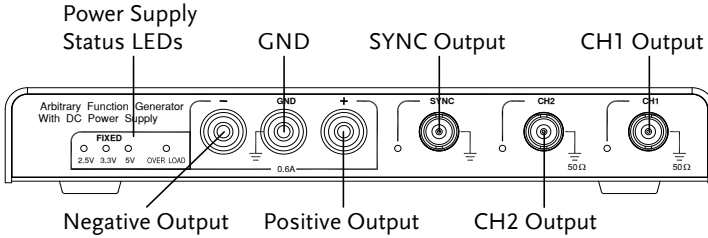

Power Supply Status LEDs

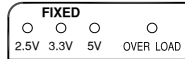

These LEDs indicate the immediate status of the power supply function on the AFG-125/225:

2.5V	2.5V output is on
3.5V	3.5V output is on
5V	5V output is on
OVER LOAD	Overload condition

Negative Output



Negative output port

GND

Ground port

Positive Output

Positive output port

SYNC

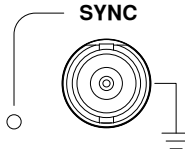

Sync output. A TTL signal is output as the sweep marker or sync output signal. See page 50 for sweep details or page 34 for sync details.

CH1

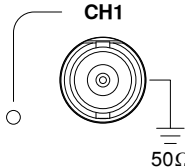

CH1 (Signal 1) output.

CH2

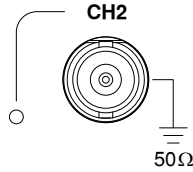

CH2 (Signal 2) output (AFG-225 only).

Rear Panel

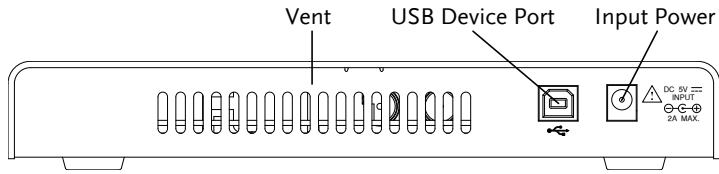

Vent

Cooling vent.

USB Device Port



Interfaces with the GDS-2000A and can also provide power.

Input Power

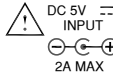

Input power source:
DC 5V; 2A max.

DS2-FH1 Housing Installation

Background The DS2-FH1 consists of 2 housings that are attached to the feet on the underside of the case.

 **Note** Make sure the power is turned off before installing the AFG-125/225 module.

- Steps**
1. Slip the housing over the front of the feet on the GDS-2000A.
 2. Make sure that the rear tab clips securely over the fan vent grid on the rear panel, as shown below.

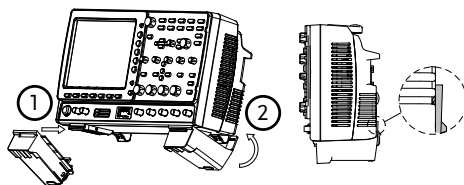

3. The AFG-125/225 module is now ready to be installed.

Module Installation/Removal

Background The AFG-125/225 modules are installed into the area that is left between both of the DS2-FH1 housings.



Note

Make sure the power is turned off before installing the AFG-125/225 module.

Installation Steps

1. Slide the module into the slot that was created between the DS2-FH1 housings. The front of the module should be facing forwards.

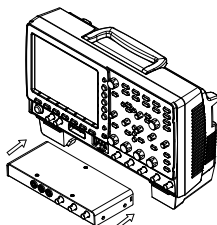

2. Make sure the module is secure. The module will click into place when it is inserted properly.
3. Make sure the GDS-2000A is turned off before proceeding.
4. Connect one end of the GTL-254 USB cable to the rear panel USB Device port and to the USB Host port. Connect the other end to the Device port on the AFG-125/225, as shown below.
5. Turn the power back on. The AFG-125/225 will now be accessible in the Option menu.

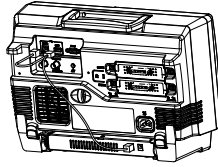

Removal

1. At the rear of the housings are two tabs. Pull both tabs outwards.
2. The module can now be slid out from the housing (back to front).

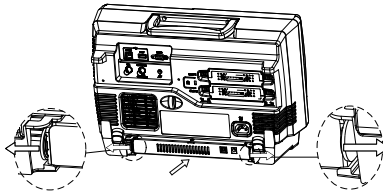

USB Configuration

Background The USB Device port needs to be configured to provide power for the AFG-125/225 if an external power supply is not used.

Steps

1. As shown previously in the “AFG-125/225 Module Installation/Removal” section, connect the GTL-254 USB cable.

2. Press the *Utility* key then *I/O* from the bottom menu.

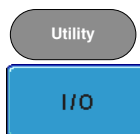

3. From the side menu press *USB Device Port* and select *USB Power*.



The port will now supply power to the AFG-125/225.



The USB Device Port should be reconfigured to “Computer” or “Printer” when the AFG-125/225 is not used. Failure to do so may damage the PC or printer when connected in the “USB Power” mode.

AFG App Installation

Background Install the AFG app as you would any application for the GDS-2000A series.

The AFG app file (AFG.gz) can be found on the User Manual CD under the APP directory.

For the latest files and information for applications, see the GW Instek website: www.gwinstek.com or contact your nearest distributor.

Steps 1. Make sure the DS2-FH1 and AFG-125/225 are installed and turned on.

Panel Operation 2. Insert a USB flash drive that has the AFG app file (AFG.gz) copied onto it into the front panel USB port.

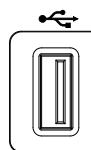

3. Press the *Utility* key then the *File Utilities* soft-key.

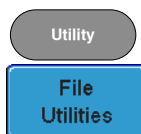

4. Navigate to the desired file in the USB file path.

VARIABLE

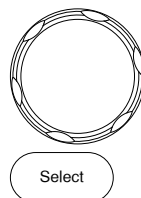

When the AFG.gz file has been found, press the *Select* key twice to start the installation.

5. The installation will complete in a few seconds. When finished a pop-up message will appear asking you to restart the GDS-2000A.
6. Restart the GDS-2000A.

Uninstalling the AFG App

Background The AFG app can be uninstalled from the TEST menu, like the other optional apps.

Panel Operation 1. Press the *Test* key.



1. Press the *APP* button from the bottom menu.



2. Use the *Variable* knob to select the AFG app.

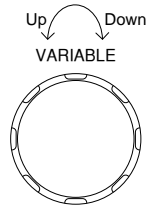

2. Press *Uninstall* on the side menu twice. Once to select and once to confirm uninstallation.



3. The uninstallation process is complete when a message showing “Please turn off the oscilloscope and turn on again” appears.

QUICK REFERENCE

This chapter describes the menu tree for the AFG-125/225.

Options Menu Tree	21
Option Key	21
Arbitrary Function Generator	22
Arbitrary Function Generator – Signal 1/2 Setup.....	23
Arbitrary Function Generator – MOD part II	24
Power Supply.....	24

Options Menu Tree

Option Key

Accesses the functions in the Option menu.

Option

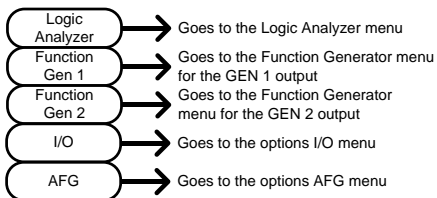
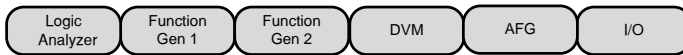
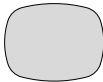

*Note: Any option that is not installed/turned on will be grayed-out.

Arbitrary Function Generator

Set up the AFG-225/125 arbitrary function generator.

Note: The Power Supply function is only available for the AFG-125P and AFG-225P

The Dual Chan and Sync Setup functions are only available for the AFG-225 and AFG-225P.

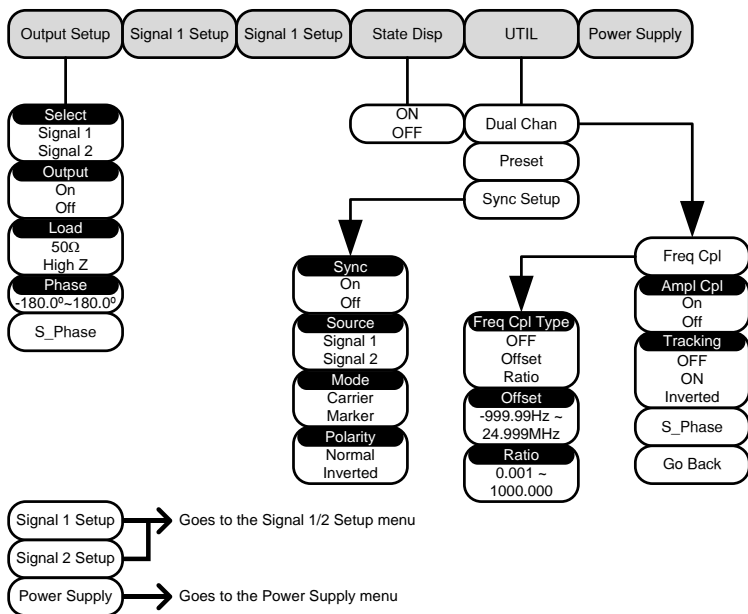

Arbitrary Function Generator – Signal 1/2 Setup

Setup the signal type for each channel. From the AFG Arbitrary Function Generator menu on page 22.

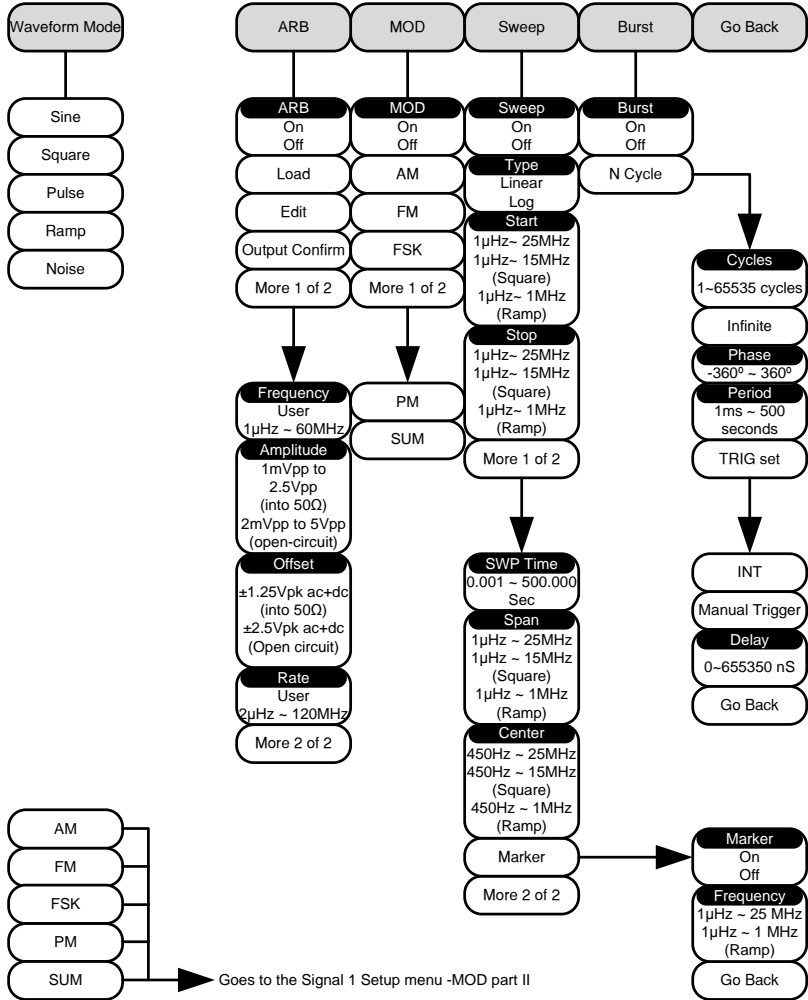

Arbitrary Function Generator – MOD part II

Configures AM, FM, FSK, PM or SUM modulation. From the Arbitrary Function Generator – Signal 1/2 Setup – MOD menu on page 23.

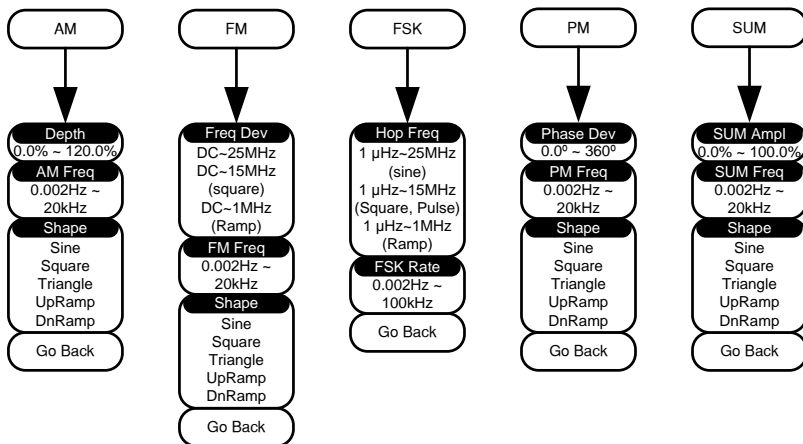

Power Supply

Power supply menu for the AFG-125P and AFG-225P.

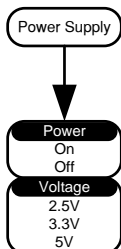

PERATION

Basic Operation	26
Entering the AFG Menu.....	26
State Display	27
Selecting a Basic Waveform.....	28
Turning the Output On	29
Dual Channel Tracking	31
Recalling the Preset Settings.....	33
Sync Setup.....	34
Modulation	40
AM Modulation.....	40
FM Modulation	42
FSK Modulation.....	44
PM Modulation	46
SUM Modulation.....	48
Sweep	50
Sweep.....	50
Burst.....	53
Burst Waveform	53
ARB.....	56
Loading a Preset ARB Waveform.....	56
Creating/Editing a Preset ARB Waveform	59
Setting ARB Output Length.....	67
Setting ARB Frequency, Rate, Amplitude & Offset.....	68

Basic Operation

Entering the AFG Menu

Background Like the other options for the GDS-2000A, the AFG option can be accessed via the front panel option key.

Panel Operation 1. Press the *Option* key.

Option



2. Press *AFG* from the bottom menu to enter the first level of the AFG menu. (The model type will be shown below the icon)



AFG Menu

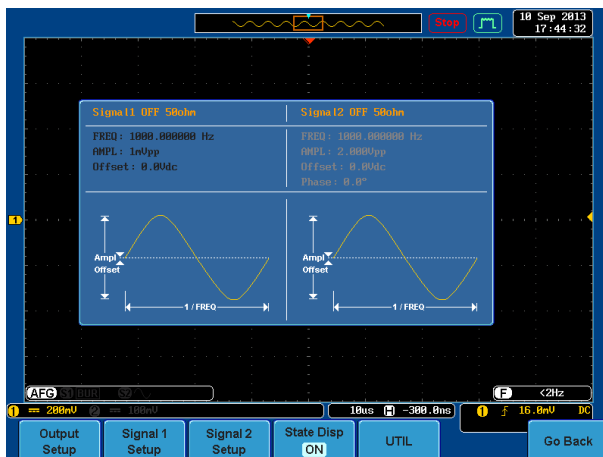

State Display

Background The state display function provides a visual display of the status of each channel and the function that is used.

The state display is on by default.

The state display is also used as a visual guide when editing/creating an ARB waveform.

State Display

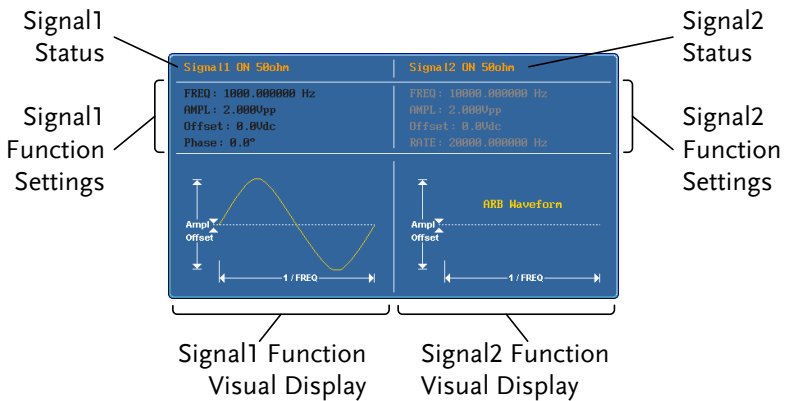

Panel Operation 1. From the first level AFG menu, press *State Disp* to toggle the display pop-up on or off.



Selecting a Basic Waveform

Background The AFG-125/225 can output 5 different types of basic waveforms: Sine, Square, Pulse, Ramp, Noise.

The basic waveforms can be output as is or they can be used as the baseband waveforms for the modulation functions or as the primary waveforms for the sweep and burst functions.

Connection 1. The AFG-125/225 arbitrary function has 2 output channels, CH1 and CH2. Each output can be selected individually.

2. Connect a BNC cable to the appropriate output (CH1 or CH2).

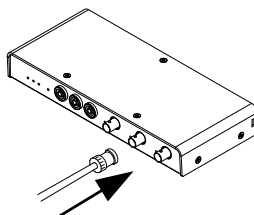

Panel Operation 1. From the first level AFG menu, select *Signal 1 Setup* or *Signal 2 Setup* from the bottom menu to select the output channel.



2. Press *Waveform Mode* from the bottom menu and then select a waveform from the side menu.

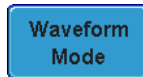

Waveforms Sine, Square, Pulse Ramp, Noise

3. See page 29 to set the output settings and turn the output on.

Page 29

Turning the Output On

Background The AFG-125/225 can output 5 different types of basic waveforms: Sine, Square, Pulse, Ramp, Noise.

The basic waveforms can be output as is or they can be used as the baseband waveforms for the modulation functions or as the primary waveforms for the sweep and burst functions.

Connection 1. The AFG-125/225 arbitrary function has 2 output channels, CH1 and CH2. Each output can be selected individually.

2. Connect a BNC cable to the appropriate output (CH1 or CH2).

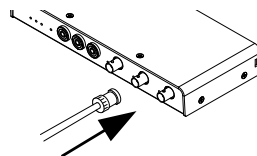

Steps 1. Press the *Output Setup* key to set the amplitude.



2. From the side menu choose the output parameters

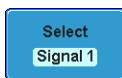

Choose the signal that will be output:

Signal 1: CH1

Signal 2: CH2

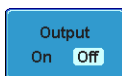

Turns the output of the selected signal on/off.

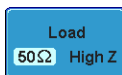

Sets the output impedance to 50Ω or High Z.



Sets the output phase relative to 0°.

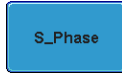

Synchronizes the phase of both channels on dual channel models.

The signal will be output as soon as the output is turned on.

Dual Channel Tracking

Background As only the AFG-225 has dual channels, it has a number of tracking functions not available on the AFG-125. The tracking functions are listed below.

Dual Channel Functions	Function	Description
	Frequency Coupling	Frequency coupling will couple the channel outputs by frequency. Frequency coupling can be achieved by frequency offset or by a frequency ratio.
	Amplitude Coupling	Amplitude coupling will couple the both channel outputs by amplitude. Any changes in amplitude in one channel is reflected in the other channel.
	Tracking	There are two tracking modes, ON and Inverted. When turned on, tracking performs frequency and amplitude tracking so the channels behave as a single channel. When set to inverted, the one channel will output the inverse of the other.
	S_Phase	S_Phase will synchronize the phase of both channels.

Steps

1. From the first level AFG menu, press *UTIL* and then press *Dual Chan* on the side menu.

 A blue rectangular button with rounded corners and a thin black border. The text "Dual Chan" is centered in white.

Dual Chan

2. From the side menu choose the relevant tracking function(s):

Freq Cpl Turns frequency coupling on and sets the type of frequency coupling:

Offset
0.0Hz Offset: Sets frequency coupling as an offset.

Ratio
1.000 Ratio: Sets frequency coupling as a ratio.

Ampl Cpl
OFF Turns amplitude coupling on or off.

Ampl Cpl: OFF, ON

Tracking
Inverted Turns tracking on or off, or turns tracking on and inverts the output of the second output.

Tracking: OFF, ON, INVERTED

S_Phase Press *S_Phase* to synchronize the phase of the both channels.

Recalling the Preset Settings

Background Recalling the preset settings will effectively reset the settings to the factory defaults.

Preset Settings	Waveform Mode	Sine
	Frequency	1 kHz
	Amplitude	1.000Vpp
	Offset	0.0Vdc
	Phase	0.0°
	Load	50Ω
	Output	Off
	ARB	Off
	MOD	Off
	Sweep	Off
	Burst	Off
	Frequency Coupling*	Off
	Amplitude Coupling*	Off
	Tracking*	Off

*Only applicable to the AFG-225.

Steps

1. From the first level of the AFG menu, press *UTIL*.



2. Press *Preset*. The preset settings will be recalled straight away.



Sync Setup

Background The sync output signal is output from the SYNC port on the front panel. The sync output signal is based on either the channel 1 or channel 2 output signals. Each periodic type of waveform output function has an associated sync output signal.

The characteristics of the sync output depend on the selected signal source.

Sync Signal Output Sine, Square, Pulse, Ramp Source For these types of waveforms, the sync output is a square wave pulse. The pulse is high for the positive transition of the waveform and low for the negative transition. The signal is a TTL level signal.

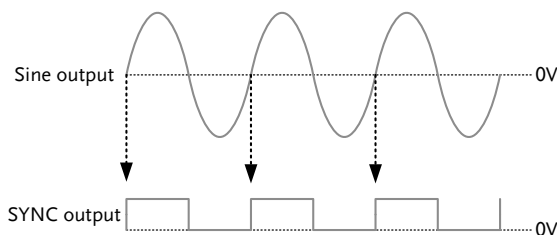

MOD waveform
Source

The sync output is a positive pulse for the positive transition of the modulating waveform and low for the negative transition. The signal is a TTL level signal.

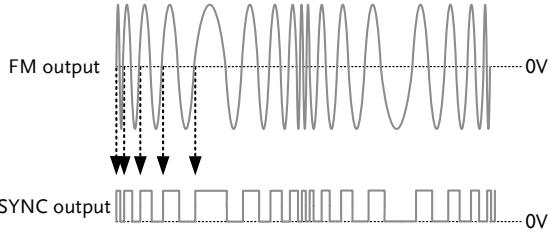

Arbitrary Waveform
Source

The ARB function can output either carrier or marker signals.

Carrier: The sync output is a single TTL positive pulse for the positive transition of the ARB waveform and low for the negative transition.

Marker: A single TTL level positive pulse is output at the start of each period of the ARB waveform.

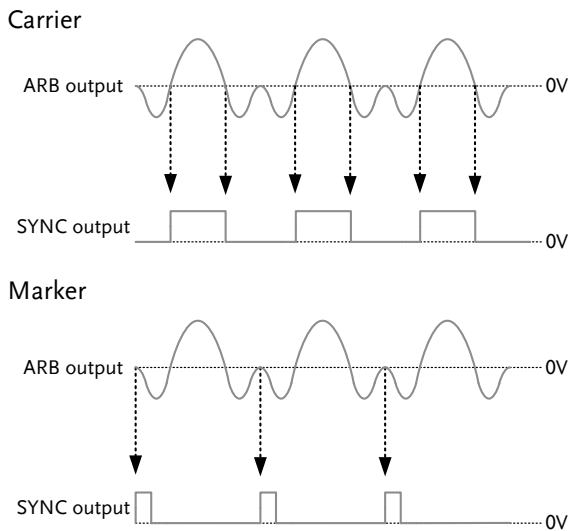

Sweep Source

The sweep function can output either carrier or marker signals.

Carrier: The sync signal output is a positive TTL level pulse for the positive transition of the sweep waveform and low for the negative transition.

Marker: The marker signal output is a TTL level positive pulse from the "marker" frequency to the stop frequency and a low level signal from the start frequency to the "marker" frequency. See page 50 to set the marker settings.

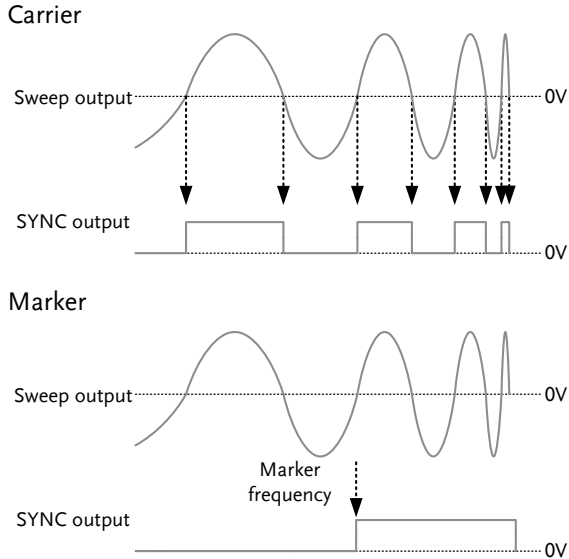

Burst Source

Like the sweep function, the burst function can output Carrier or Marker signals from the SYNC output.

Carrier: The sync signal output is a positive TTL level pulse for the positive transition (0V and above) of the burst waveform and low for the negative transition.

Marker: The marker signal output is a TTL level positive pulse for the duration of the burst period and low for the remainder of waveform period

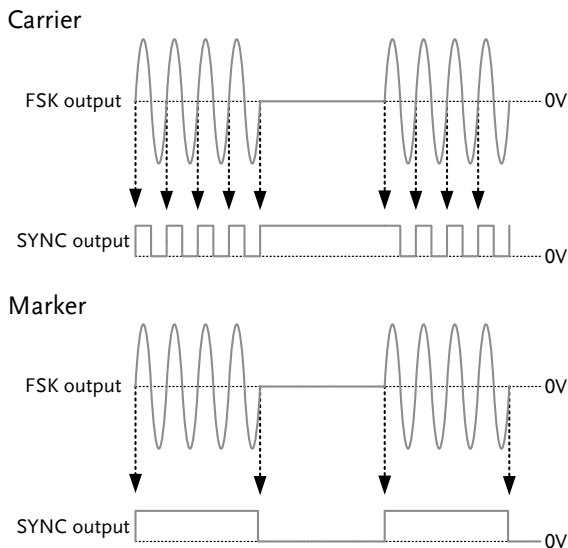

Steps

1. From the first level of the AFG menu, press *UTIL* and then press *Sync Setup* on the side menu.



2. From the side menu choose the sync setting:

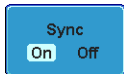

The Sync function will turn the sync output on for all waveforms except for noise.

(Note: If *Marker* is turned on in the *Sweep* function, the *Sync On* setting will be overridden.



Selects the source signal on which to base the sync signal.

Source: Signal 1, Signal 2

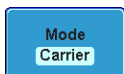

When *Sync* is on, You can force the sync signal to follow the carrier or the marker* mode.

Mode: Carrier, Marker

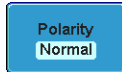

The polarity can be set to Normal or Inverted.

Polarity: Normal, Inverted



Note





The marker mode can only be used for the ARB and mod waveforms.

For the Sweep function, the marker output must be turned on in the Sweep function menu. It cannot be activated in the Sync Setup menu. See page 51 to turn the marker option on.

Modulation

AM Modulation

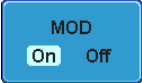
Background The AM Modulation function can set the carrier frequency (AM Freq), amplitude modulation depth (Depth) and carrier waveform (Shape).

- | | | |
|--------------|---|---|
| Steps | <ol style="list-style-type: none"> 1. Set the carrier waveform and frequency. You can set the carrier waveform and frequency in the <i>Selecting a Basic Waveform</i> section. | Page 26 |
| | <ol style="list-style-type: none"> 2. From the first level of the AFG menu, press the <i>Signal 1 Setup</i> or <i>Signal 2 Setup</i> key to select the signal source. |  |
| | <ol style="list-style-type: none"> 3. From the bottom menu press <i>MOD</i>. |  |
| | <ol style="list-style-type: none"> 4. From the side menu turn <i>MOD On</i> and then select the <i>AM</i> modulation. |  |
| | |  |
-



Note

Only one modulation mode can be active at any one time. The function generator also will not allow sweep, burst or ARB mode to be used with a modulation function. Activating a modulation mode will turn the previous modulation mode off.

5. Select the AM parameters from the side menu:

Depth
100.0%

Sets the amplitude modulation depth: 0~ 120%

AM Freq
100.00Hz

Sets the AM frequency: 2 mHz~20kHz.

Shape
Sine

Sets the carrier waveform shape: Sine, Square, Triangle, Up ramp, Dn ramp.

6. See page 29 to set the output settings and turn the output on. Page 29



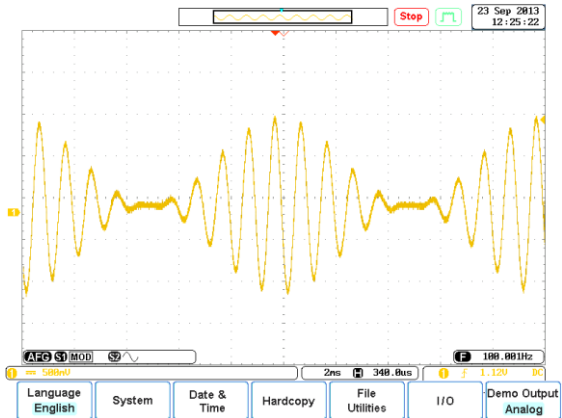

Example



Amplitude Modulation

FM Modulation

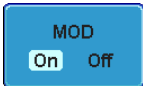
Background The FM Modulation function can set the carrier frequency (FM Freq), frequency deviation (FM DEV) and carrier waveform (Shape).

- | | | |
|--------------|---|--|
| Steps | <ol style="list-style-type: none"> 1. Set the carrier waveform and frequency. You can set the carrier waveform and frequency in the <i>Selecting a Basic Waveform</i> section. | Page 26 |
| | <ol style="list-style-type: none"> 2. From the first level of the AFG menu, press the <i>Signal 1 Setup</i> or <i>Signal 2 Setup</i> key to select the signal source. |  |
| | <ol style="list-style-type: none"> 3. From the bottom menu press <i>MOD</i>. |  |
| | <ol style="list-style-type: none"> 4. From the side menu turn <i>MOD On</i> and then select the <i>FM</i> modulation. |  |
| | |  |

 **Note**

Only one modulation mode can be active at any one time. The function generator also will not allow sweep, burst or ARB mode to be used with a modulation function. Activating a modulation mode will turn the previous modulation mode off.

5. Select the FM parameters from the side menu:

- Freq Dev**
 100.00Hz

 Sets the frequency deviation:
 DC~25MHz
 DC~15MHz(square)
 DC~1MHz (Ramp)

- FM Freq**
 100.00Hz

 Sets the FM frequency:
 2mHz~20kHz.

- Shape**
 Sine

 Sets the carrier waveform shape:
 Sine, Square, Triangle, Up ramp,
 Dn ramp.

6. See page 29 to set the output settings and turn the output on. Page 29



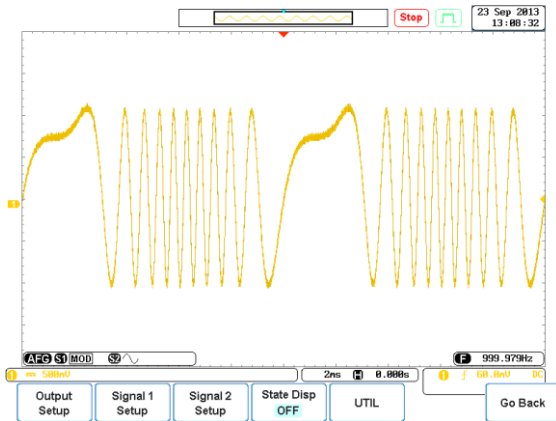

Example



Frequency Modulation

FSK Modulation

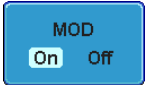
Background The FSK Modulation function can set the hop frequency (FSK Hop) and the frequency-shift keying rate (FSK Rate). FSK Modulation essentially jumps between the carrier frequency and the hop frequency at a rate determined by the FSK rate frequency.

- | | | |
|--------------|---|---|
| Steps | <ol style="list-style-type: none"> 1. Set the carrier waveform and frequency. You can set the carrier waveform and frequency in the <i>Selecting a Basic Waveform</i> section. | Page 26 |
| | <ol style="list-style-type: none"> 2. From the first level of the AFG menu, press the <i>Signal 1 Setup</i> or <i>Signal 2 Setup</i> key to select the signal source. |  |
| | <ol style="list-style-type: none"> 3. From the bottom menu press <i>MOD</i>. |  |
| | <ol style="list-style-type: none"> 4. From the side menu turn <i>MOD On</i> and then select the <i>FSK</i> modulation. |  |
| | |  |

 **Note**

Only one modulation mode can be active at any one time. The function generator also will not allow sweep, burst or ARB mode to be used with a modulation function. Activating a modulation mode will turn the previous modulation mode off.

5. Select the FSK parameters from the side menu:

- Hop Freq
 100.00Hz

 Sets the hop frequency:
 1 μ Hz~25MHz (Sine)
 1 μ Hz~15MHz (Square, Pulse)
 1 μ Hz~1MHz (Ramp)

- FSK Rate
 10.00Hz

 Sets the FSK rate:
 2mHz~100kHz.

6. See page 29 to set the output settings and turn the output on. Page 29

Example

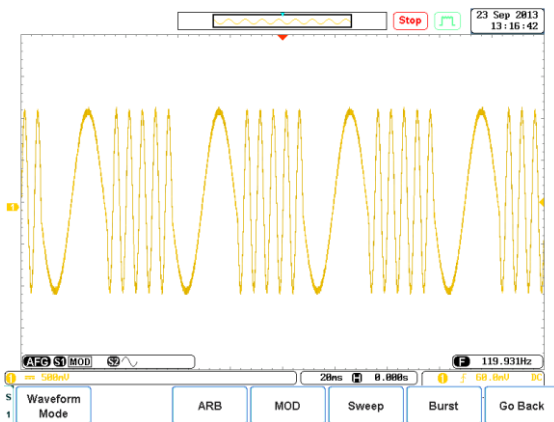



Frequency-Shift Keying Modulation

PM Modulation

Background The PM Modulation function can set the phase modulation frequency (PM Freq), phase deviation (Phase Dev) and the PM shape (Shape).

The phase deviation of the carrier waveform deviates from a reference phase value in proportion to changes in the modulating waveform.

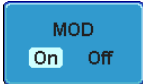
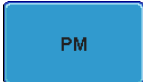
- | | | |
|--------------|---|---|
| Steps | <ol style="list-style-type: none"> 1. Set the carrier waveform and frequency. You can set the carrier waveform and frequency in the <i>Selecting a Basic Waveform</i> section. | Page 26 |
| | <ol style="list-style-type: none"> 2. From the first level of the AFG menu, press the <i>Signal 1 Setup</i> or <i>Signal 2 Setup</i> key to select the signal source. |  |
| | <ol style="list-style-type: none"> 3. From the bottom menu press <i>MOD</i>. |  |
| | <ol style="list-style-type: none"> 4. From the side menu turn <i>MOD On</i>, press <i>more 1 of 2</i> and then select the <i>PM</i> modulation. | 
 |

 **Note**

Only one modulation mode can be active at any one time. The function generator also will not allow sweep, burst or ARB mode to be used with a modulation function. Activating a modulation mode will turn the previous modulation mode off.

5. Select the PM parameters from the side menu:



Sets the phase deviation: $0^\circ \sim 360^\circ$

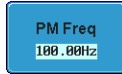

Sets the phase modulation frequency: 2mHz ~ 20kHz



Sets the PM wave shape:
Sine, Square, Triangle, UpRamp,
DnRamp.

6. See page 29 to set the output settings and turn the output on. Page 29

Example

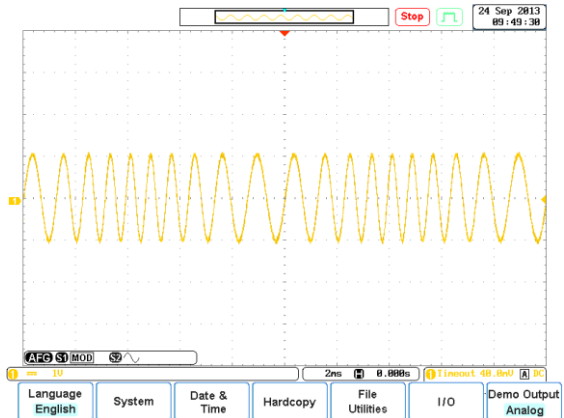



Pulse Modulation

SUM Modulation

Background The SUM Modulation function can set the SUM amplitude (SUM Ampl) the carrier frequency (SUM Freq) and carrier waveform (Shape).

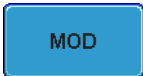
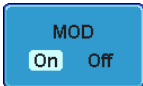
In general SUM modulation adds a modulating signal to a carrier wave. Typically, sum modulation is used to add noise to a carrier wave. The modulating signal is added as a percentage of the carrier amplitude.

- | | | |
|--------------|---|---|
| Steps | <ol style="list-style-type: none"> 1. Set the carrier waveform and frequency. You can set the carrier waveform and frequency in the <i>Selecting a Basic Waveform</i> section. | Page 26 |
| | <ol style="list-style-type: none"> 2. From the first level of the AFG menu, press the <i>Signal 1 Setup</i> or <i>Signal 2 Setup</i> key to select the signal source. |  |
| | <ol style="list-style-type: none"> 3. From the bottom menu press <i>MOD</i>. |  |
| | <ol style="list-style-type: none"> 4. From the side menu turn <i>MOD On</i>, press <i>more 1 of 2</i> and then select the <i>SUM</i> modulation. |  |
| | |  |



Only one modulation mode can be active at any one time. The function generator also will not allow sweep, burst or ARB mode to be used with a modulation function. Activating a modulation mode will turn the previous modulation mode off.

5. Select the SUM parameters from the side menu:

SUM Ampl ↻ 50.0%	Sets the SUM amplitude (relative to the carrier): 0.0% ~ 100.0%
SUM Freq 100.00Hz	Sets SUM modulation frequency: 2mHz ~ 20kHz
Shape Sine	Sets the SUM wave shape.

6. See page 29 to set the output settings and turn the output on. Page 29

Example

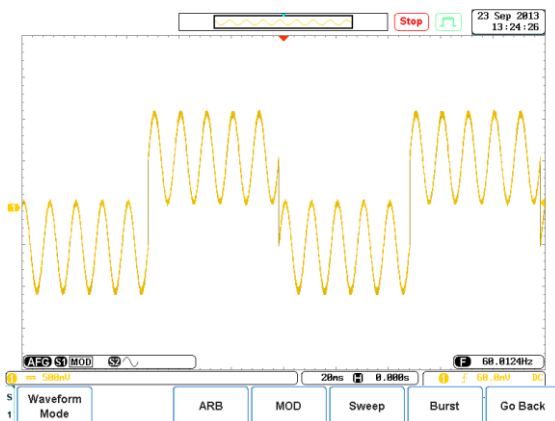



SUM Modulation

Sweep

Sweep

Background The AFG-125/225 can perform a sweep for sine, square or ramp waveforms. In Sweep mode, the function generator will sweep from a start frequency to a stop frequency. The sweep can be performed in a linear or logarithmic fashion. The AFG-125/225 can also output a TTL signal from the SYNC output when the marker function is turned on.

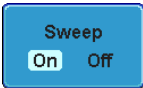
- | | | |
|--------------|---|---|
| Steps | <ol style="list-style-type: none"> 1. Set the carrier waveform and frequency. You can set the carrier waveform and frequency in the <i>Selecting a Basic Waveform</i> section. | Page 26 |
| | <ol style="list-style-type: none"> 2. From the first level of the AFG menu, press the <i>Signal 1 Setup</i> or <i>Signal 2 Setup</i> key to select the signal source. |  |
| | <ol style="list-style-type: none"> 3. From the bottom menu press <i>Sweep</i>. |  |
| | <ol style="list-style-type: none"> 4. From the side menu turn <i>Sweep On</i>. |  |

 **Note**

Only one modulation mode can be active at any one time. The function generator also will not allow sweep, burst or ARB mode to be used with a modulation function. Activating a modulation mode will turn the previous modulation mode off.

5. Select the sweep parameters from the side menu:



Selects the type of sweep: logarithmic or linear.



Sets the start frequency*:
 1 μ Hz ~ 25MHz
 1 μ Hz ~ 15MHz (Square)
 1 μ Hz ~ 1MHz (Ramp)



Sets the Stop frequency*:
 1 μ Hz ~ 25MHz
 1 μ Hz ~ 15MHz (Square)
 1 μ Hz ~ 1MHz (Ramp)

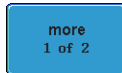

Press to access the remaining sweep settings, shown below:



Sets the sweep time: 1ms ~ 500s.



Sets the Span*:
 1 μ Hz ~ 25MHz
 1 μ Hz ~ 15MHz (Square)
 1 μ Hz ~ 1MHz (Ramp)

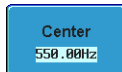

Sets the center frequency*.



Note

*Setting the Start and Stop frequencies will override the Span and Center settings, and conversely setting the Span and Center settings will override the Start and Stop settings.

Marker

6. To set a marker signal, press Marker and turn Marker On. The marker will output a TTL-level square wave signal at the designated frequency from the SYNC output port.

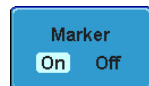

- Press Frequency and set a marker frequency. The marker frequency cannot be lower than the center frequency.

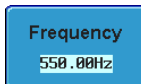

1 μ Hz ~ 25MHz
 1 μ Hz ~ 1MHz (Ramp)

- See page 29 to set the output settings and turn the output on.

Page 29

Example

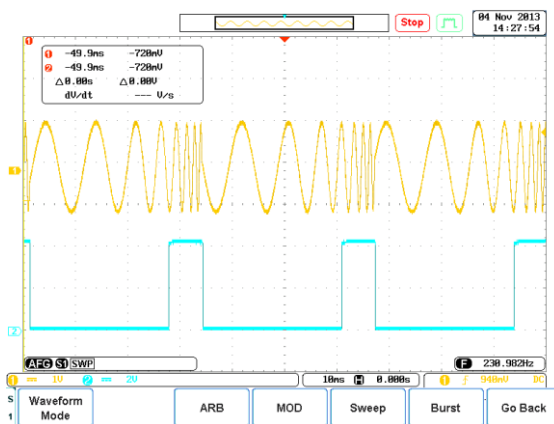

Sweep Waveform (CH1) with marker output (CH2).

Burst

Burst Waveform

Background The function generator can create a waveform burst with a designated number of cycles. Burst mode supports sine, square and ramp waveforms.

Steps 1. Set the carrier waveform and burst frequency. You can set the carrier waveform and burst frequency in the *Selecting a Basic Waveform* section. Page 26

2. From the first level of the AFG menu, press the *Signal 1 Setup* or *Signal 2 Setup* key to select the signal source.



3. From the bottom menu press *Burst*.

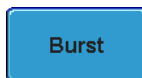

4. From the side menu turn *Burst On*.

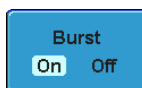

Only one modulation mode can be active at any one time. The function generator also will not allow sweep, burst or ARB mode to be used with a modulation function. Activating a modulation mode will turn the previous modulation mode off.

5. Press *N Cycle* from the side menu.



6. Select the *N Cycle* parameters from the side menu:



Sets the number of burst cycles* : 1~ 65,535, infinite.

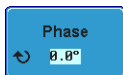

Sets the starting phase of the burst waveform.

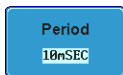

Sets the period* length in seconds for the burst waveform.



Note

*The Period setting will affect the number of cycles that can be chosen for any given frequency. The relationship is shown in the following equation:

$$\text{Burst Cycle} < (\text{Burst Period} \times \text{Wave Frequency})$$

Trigger Settings

7. Press *Trigger set* from the side menu.



8. Select the Trigger parameters from the side menu:



Sets the trigger as internal. An internal trigger is generated at the end of each period.

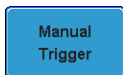

Sets the trigger to Manual mode. This Manual Trigger key must be pressed each time to output a burst waveform.

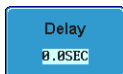

Sets a delay time between the trigger and the burst waveform output: 0 ~ 655350nS.

9. See page 29 to set the output settings and to turn the output on.

Page 29

Example

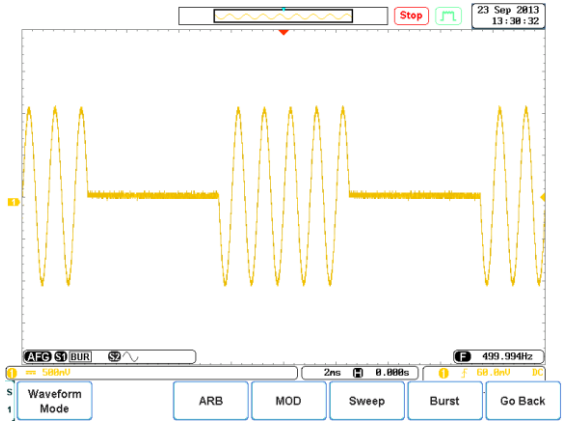

Burst Waveform

ARB

Loading a Preset ARB Waveform

Background The AFG-225 can load a number of different waveforms as an arbitrary waveform file: CH1~CH4, Ref1~Ref4, Wave1~Wave20, a previously saved waveform (LSF and fast CSV format*), a previously created ARB waveform or one of the 66 preset ARB waveforms**. The preset waveforms are categorized into Common, Math, Window and Engineer waveforms, as shown in the table below.

* See the DSO user manual for save file formats.

** See the appendix on page 72 for a full list and description of the preset ARB waveforms.

Preset waveforms

Common:
Absatan, Abssin, Abssinehalf, Ampalt, Attalt, Direven, Diriodd, Gauspuls, Havercos, Haversin, Negramp, N_pulse, Rectpuls, Roundhaf, Sawtooth, Sinetra, Sinever, Stair_dw, Stair_ud, Stair_up, stepresp, trapezia, tripuls
Math:
Arccos, Arccot, Arccsc, Arcsec, Arcsin, Arcsinh, Arctan, Arctanh, Cosh, Cot, Csc, Dlorentz, Expofall, Exporise, Gauss, Ln, Lorentz, Sec, Sech, Sinec, Sinh, Sqrt, Tan, Tanh, Xsquare
Window:
Barthwin, Bartlett, Blackman, Bohmwin, Chebyshe, Flattwin, Hamming, Hann, Hanning, Kaiser, Triang, Tukeywin
Engineer:

Airy, Bessel, Betainc, Gamm, Legendre, Neumann

Steps

1. From the first level of the AFG menu, press the *Signal 1 Setup* or *Signal 2 Setup* key to select the signal source.



2. From the bottom menu press *ARB*.



3. From the side menu turn *ARB On*.



Note

The function generator also will not allow ARB to be turned on when sweep, burst or a modulation function is active. Turn off any other active modes before using ARB mode.

4. Press *Load* from the side menu.



5. You can load an ARB waveform from one of the source channels, from internal memory or from a number of predefined waveforms:



Press *From* to select an input channel or internally saved waveform.

From: CH1 ~ CH4

Ref1 ~ Ref4

Math

Wave1 ~ Wave20



Press *From File* to load a previously saved waveform or a predefined waveform.

From File: LSF, Fast CSV, User
Preset, Common, Math,
Window, Engineer

File Utilities

If a previously saved waveform or predefined waveform type was chosen above, use the *File Utilities* to select the desired ARB waveform.

Recall Now

Press *Recall Now* to load the ARB waveform.

A message will appear on the screen when the ARB waveform is successfully recalled.

Example



Triangle Pulse waveform

Creating/Editing a Preset ARB Waveform

Background The AFG-125/225 has a number of methods to create and edit arbitrary waveforms. The ARB waveforms can have a maximum of 4096 (0~4095) points in length and 1023 (0±511) points in amplitude.

Editing Methods **Point/Line:**
Creates a vertical line of a user-defined length and amplitude.

Diagonal:
Creates a diagonal line of a user-defined length and amplitude.

Scale:
Scales the full-scale of the ARB waveform.

Copy/Paste:
This method will copy and paste a user-defined section of the ARB waveform.

Clear:
This will clear a user-defined section of the ARB waveform.

Note: By default, any section of the ARB waveform that is not edited will be set to 0Vpp. By default the editing will automatically match the amplitude of each point.

Steps

1. From the first level of the AFG menu, press the *Signal 1 Setup* or *Signal 2 Setup* key to select the signal source.



2. From the bottom menu press *ARB*.



3. From the side menu turn *ARB* On.

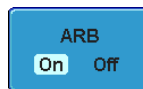

Note

The function generator also will not allow ARB to be turned on when sweep, burst or a modulation function is active. Turn off any other active modes before using ARB mode.

4. Press *Edit* from the side menu.



Point/Line Editing

5. Press *Edit Method* and choose *Point Line*.

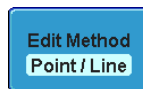

6. Press *Action* to begin editing the waveform using the Point/Line method.



7. Use the side menu to create a point or vertical line:



Press *Address* to set the starting address of the line or point.

The maximum address depends on the Length setting below:

$$\text{Max address} = 4096 - \text{Length}$$

Range: 0 ~ 4095



Press *Length* to set the length of the line. The maximum length depends on the address set above:

$$\text{Max length} = 4096 - \text{Address}$$

Length 1 ~ 4096

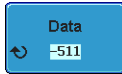

Press *Data* to set the amplitude of the point/line.

Data -511 ~ 0 ~ +511



When the point/line has been edited, press *Preview* to view the edited line.

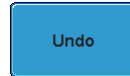

Press *Undo* to cancel the point/line edit.

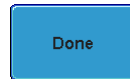

Press *Done* to confirm and save the point/line edit.

Example



Figure showing a horizontal line (black highlight)

Diagonal Editing 1. Press *Edit Method* and choose *Diagonal*.

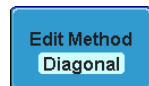

2. Press *Action* to begin editing the waveform using the Diagonal method.



3. Use the side menu to create a diagonal line:

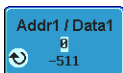

Press *Addr1/Data1* to set the first data point for the diagonal line. Press once to set the Addr1, press again to set Data1 (amplitude).

Addr1 range: 0 ~ 4095

Data1 range: ±511

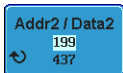

Press *Addr2/Data2* to set the second data point for the diagonal line. Press once to set the Addr2, press again to set Data2 (amplitude).

Addr2 range: 0 ~ 4095

Data2 range: ±511

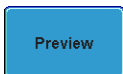

When the line has been edited, press *Preview* to view the edited line.

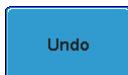

Press *Undo* to cancel the line edit.

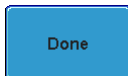

Press *Done* to confirm and save the line edit.

Example



Figure showing a diagonal line (black highlight).

Scale Editing

1. Press *Edit Method* and choose *Scale*.



2. Press *Action* to begin editing the waveform using the Scale method.



3. Use the side menu to set the scale:

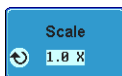

The scale function sets the vertical scaling factor* for the whole ARB waveform.

Scale 0.1 ~ 10X

Example



Figure of 2.0X scaling. Notice that the waveform is clipped at the bottom.



Note

* If any data points that exceed a magnitude of ± 511 will be clipped.

Copy / Paste

1. Press *Edit Method* and choose *Copy/Paste*.

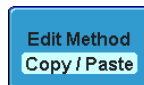

2. Press *Action* to enter the Copy/Paste menu.

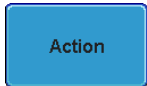

3. Use the side menu to copy a section of the ARB waveform:

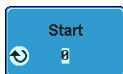

Press *Start** to set the start address of the section you want to copy.

Start range: 0 ~ 4095

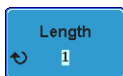

Press *Length** to set the length of the section you wish to copy.

Length range 1~ 4096

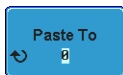

Press *Paste To* to choose the position to paste the copied section of waveform**.

Paste range 0~ 4095

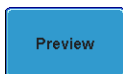

When the copy and paste areas have been selected, press *Preview* to view the result.



Press *Undo* to cancel the copy/paste operation.

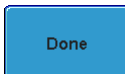

Press *Done* to confirm and save the copy/paste operation.

Example

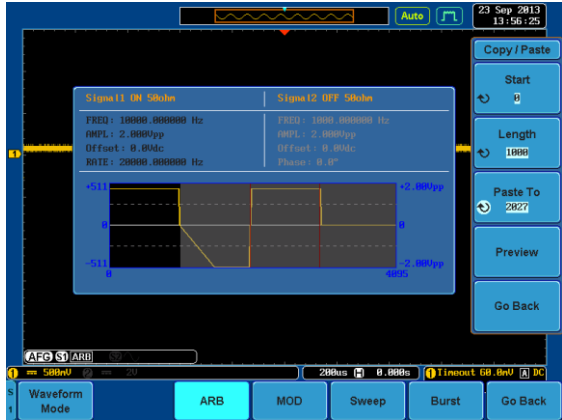

Figure showing the copied section (black) and the pasted section (red bars).



Note

* The maximum start address depends on the Length setting: $\text{Max Start} = 4096 - \text{Length}$

The maximum length depends on the start address set above: $\text{Max Length} = 4096 - \text{Start}$

** You cannot paste over an area that was originally copied. For example, if you copy from points 100 ~ 200, you cannot paste that to points 150 ~ 250. A setting conflict error will appear on the screen when the “Copy” and “Paste To” area overlap.

Clear

1. Press *Edit Method* and choose *Clear*.



2. Press *Action* to enter the Clear menu.



3. Use the side menu to select a section of the ARB waveform to clear or to clear the whole ARB waveform:

- Start**
↻ 0

Sets the start address of the section of the ARB waveform to be cleared.

Start range 0 ~ 4095
- Length**
↻ 1

Sets the length of the section of the ARB waveform to be cleared.

Length range 1 ~ 4096
- Done**

Press Done to confirm and then clear the selected section of the ARB waveform.
- All**

Press Done to clear the whole ARB waveform instantly.

Example

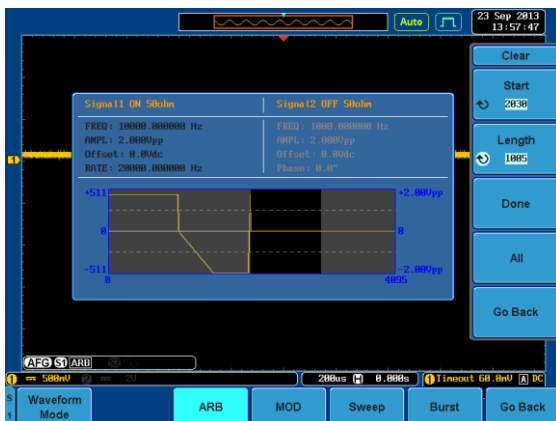

Figure showing the cleared section of the waveform.

Saving the ARB Waveform

After you have created/edited your waveform, you can save it for use at a later time. See page 56 to load a User Preset ARB waveform.

1. Press Save Now to save the ARB waveform to the current directory.



Setting ARB Output Length

Background The Output Confirm menu allows the user to specify a section of the ARB waveform to be output.

The length of the outputted section will directly affect the possible frequency or rate of the ARB waveform. See page 68 for details.

Steps

1. From the ARB menu press *Output Confirm*.



2. Select the section of the ARB waveform that you wish to have output from the side menu:



Press Start* to set the start address for the output section.

Press Length* to set the total length of the output section.

Example

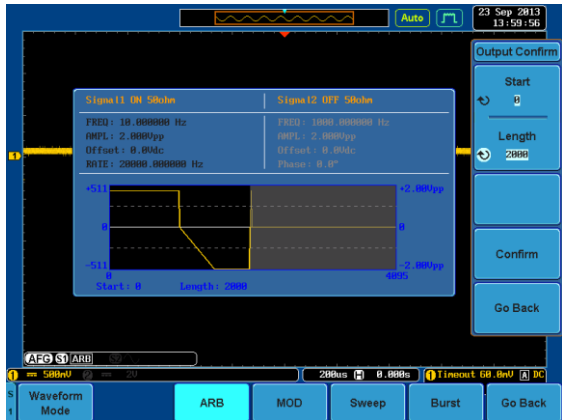

Output section is shown in black.



Note

* The maximum length depends on the start address setting.

The maximum length = 4096 – Start address.

3. Press Confirm to set the chosen output section.



4. See page 29 to set the output settings and turn the output on.

Page 29

Setting ARB Frequency, Rate, Amplitude & Offset

Background

The rate, frequency, amplitude and (amplitude)offset output parameters can also be set.

Steps

1. From the ARB menu press *more 1 of 2*.

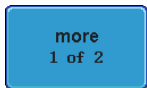

2. Select the parameters from the side menu:

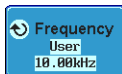

Sets the frequency* of the ARB waveform.

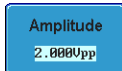

Sets the amplitude** of the waveform:
1mVpp to 2.5Vpp (into 50Ω)
2mVpp to 5Vpp (open-circuit)



Sets the Offset** of the ARB waveform:
±1.25Vpk ac +dc (into 50Ω)
±2.5Vpk ac +dc (Open circuit)



Sets the rate of the ARB waveform*. This will set the number of times the ARB waveform will be output each second.



*The frequency setting is inversely proportional to the Rate setting. The frequency and rate settings are also directly affected by the length of the output ARB waveform. See page 67 for setting the output length of the ARB waveform.

**The amplitude and offset are linked. Together the amplitude and offset cannot exceed 2.5Vpp (into 50Ω).

3. See page 29 to set the output settings and turn the output on. Page 29

Power Supply Function

Using the Power Supply Function (AFG-125P & AFG-225P only)

Background The AFG-125P and AFG-225P have an additional power supply function. The power supply has three fixed output levels: 2.5V, 3.3V, 5V.

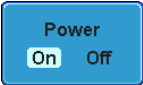
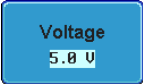
- Steps**
1. Press *Power Supply* from the first level of the AFG menu. 
 2. Press *Power* to turn the power supply output on. 
 3. Press *Voltage* to select one of the fixed output levels. Status LEDs on the front panel will light up appropriately. 
- Voltage 2.5V, 3.3V, 5V
-

 **Note**

The current power supply has a current output of 6A and a voltage output of (2.5V, 3.3V or 5V)±5%.

If the power supply is overload, the OVER LOAD LED on the front panel will light up.



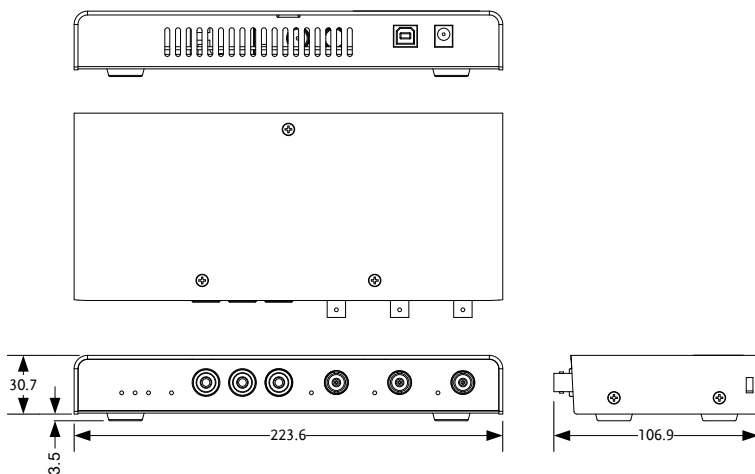

A PPENDEX







Dimensions

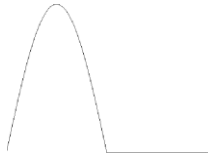
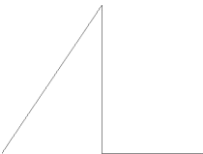
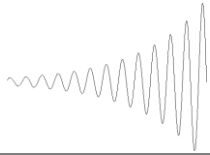
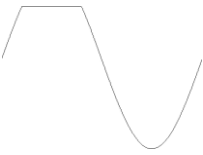

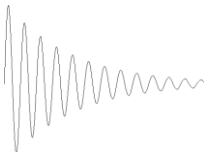
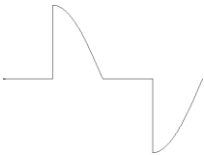

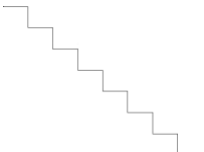
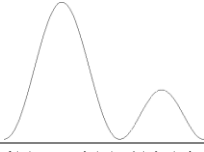
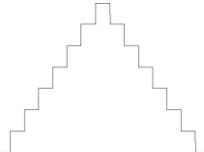
Preset ARB Waveform

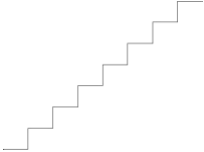

Common

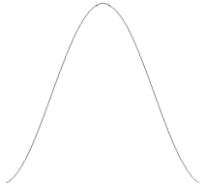
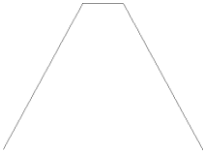
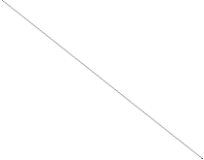
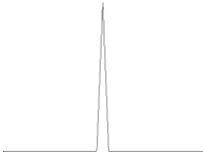
Function	Description	Function	Description
ABSATAN	$y = \text{atan}(x) $ The absolute of atan(x)	RECTPULS	Sampled aperiodic rectangle
			
ABSSIN	$y = \sin(x) $ The absolute of sin(x)	ROUNDHAF	$y = \sqrt{1-x^2}$ Half round function
			
ABSINEH	$y = \sin(x), 0 < x < \pi$ $y = 0, \pi < x < 2\pi$ Half-wave function	SAWTOOT	Sawtooth or triangle wave
			
AMPALT	$y = e(x) \cdot \sin(x)$ Oscillation rise	SINETRA	Piecewise function
			







ATTALT	$y=e^{-x} \cdot \sin(x)$ Oscillation fall	SINEVER	Piecewise function
			
DIRIEVEN	Even $f(x)=-1^{(x*(n-1)/2*\pi)}$ $x=0, \pm 2*\pi, \pm 4*\pi, \dots$	STAIR_DW	Step down
			
DIRIODD	Odd $f(x)=\sin(nx/2)/n*\sin(x/2)$ $x=\pm\pi, \pm 3\pi, \dots$	STAIR_UD	Step up and step down
			
GAUSPULS	$f(x)=a*e^{-(x-b)^2/c^2}$ Gaussian-modulated sinusoidal pulse	STAIR_UP	Step up
			
HAVERCOS	$y=(1-\sin(x))/2$ Havercosine function	STEPRESP	Heaviside step function
			

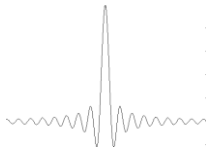

<p>HAVERSIN $= (1 - \cos(x)) / 2$ Haversine function</p> 	<p>TRAPEZIA Piecewise function</p> 
<p>NEGRAMP $y = -x$ Line segment</p> 	<p>TRIPULS Sampled aperiodic triangle</p> 
<p>N_PULSE Negative pulse</p> 	

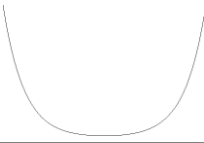
Math

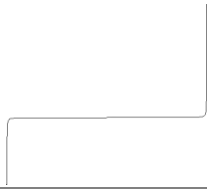
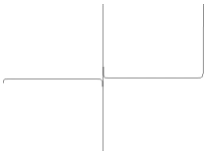

Function	Description	Function	Description
ARCCOS	Basic trigonometric function	EXPORISE	Exponential rise
			

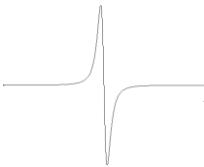
ARCCOT	Basic trigonometric function	GAUSS	A waveform representing a gaussian bell curve
ARCCSC	Basic trigonometric function	LN	Logarithm function
ARCSEC	Basic trigonometric function	LORENTZ	The derivative of the lorentz function $y=1/(k*x^2+1)$
ARCSIN	Basic trigonometric function	SEC	Basic trigonometric function
ARCSINH	Basic trigonometric function	SECH	Basic trigonometric function

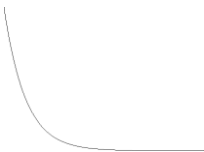
ARCTAN	Basic trigonometric function	SINEC	$y=\sin(x)/x$
			
ARCTANH	Basic trigonometric function	SINH	Basic trigonometric function
			
COSH	Basic trigonometric function	SQRT	$y=\sqrt{x}$
			
COT	Basic trigonometric function	TAN	Basic trigonometric function
			
CSC	Basic trigonometric function	TANH	Basic trigonometric function
			

<p>DLORENTZ</p>	<p>The derivative of the lorentz function. $y = -2x / (k^2x^2 + 1)$</p> 	<p>XSQUARE</p>	<p>Parabola</p> 
<p>EXPOFALL</p>	<p>Exponential decay</p> 		

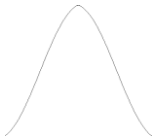
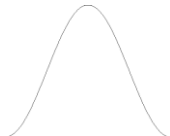
Window

Function	Description	Function	Description
<p>BARTHWIN</p>	<p>Modified Bartlett-Hann window</p> 	<p>HAMMING</p>	<p>The Hamming window function</p> 
<p>BARTLETT</p>	<p>The Bartlett window is very similar to a triangular window as returned by the TRIANG function.</p> 	<p>HANN</p>	<p>The Hann window function</p> 

BLACKMAN	The Blackman window function	HANNING	The Hanning window function
BOHMWIN	The Bohman window function	KAISER	The Kaiser window function
CHEBYSHE	The Chebyshev window function	TRIANG	The Triang window function
FLATTWIN	The Flattopwin window function	TUKEYWIN	The Tukey window function

Engineer

Function	Description	Function	Description
AIRY	The Airy function	GAMM	The Gamma function

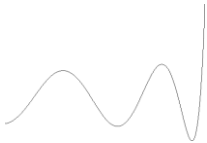
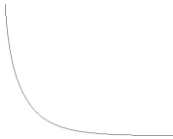
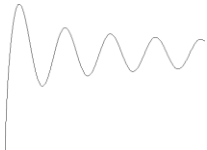
BESSEL	The Bessel function	LEGENDRE	Associated Legendre functions
			
BETA	The Beta function	NEUMANN	The Neumann function
			

Declaration of Conformity

We

GOOD WILL INSTRUMENT CO., LTD.

No. 7-1, Jhongsing Rd, Tucheng Dist., New Taipei City 236, Taiwan

GOOD WILL INSTRUMENT (SUZHOU) CO., LTD.

No. 69 Lushan Road, Suzhou New District Jiangsu, China.

declare that the below mentioned products

Type of Product: Arbitrary Function Generator (With DC Power Supply)

Model Number: AFG-125, AFG-225, AFG-125P & AFG-225P

are herewith confirmed to comply with the requirements set out in the Council Directive on the Approximation of the Law of Member States relating to Electromagnetic Compatibility (2004/108/EC).

For the evaluation regarding the Electromagnetic Compatibility, the following standards were applied:

© EMC	
EN 61326-1:	Electrical equipment for measurement, control and laboratory use -- EMC requirements (2013)
Conducted and Radiated Emissions EN 55011: 2009+A1: 2010	Electrostatic Discharge EN 61000-4-2: 2009
Current Harmonic EN 61000-3-2: 2006+A1: 2009+A2: 2009	Radiated Immunity EN 61000-4-3: 2006+A1: 2008+A2 :2010
Voltage Fluctuation EN 61000-3-3: 2008	Electrical Fast Transients EN 61000-4-4: 2012
-----	Surge Immunity EN 61000-4-5: 2006
-----	Conducted Susceptibility EN 61000-4-6: 2009
-----	Power Frequency Magnetic Field EN 61000-4-8: 2010
-----	Voltage Dips/Interrupts EN 61000-4-11: 2004

INDEX

Accessories	11	Entering the ARB function	
AFG menu	26	menu	26
App installation	18	Environment	
App uninstallation.....	19	safety instructions	6
Appendix	71	front panel diagram	12
ARB		Function generator	
Amplitude	68	operation	26
Clear.....	65	Fuse	
copy/paste.....	63	type	5
diagonal line.....	61	Ground	
Editing.....	59	symbol.....	4
Frequency	68	List of features	10
line	60	Main features.....	10
Load waveforms	56	Menu tree	21
Offset	68	Modulation	
Output	67	AM	40
point.....	60	FM	42
Preset waveform list	72	FSK.....	44
Preset waveforms	56	PM.....	46
Rate	68	SUM	48
Save.....	66	Module installation.....	15
scale	63	Module removal.....	15
Baseband waveforms	28	Operation	25
Basic waveforms	28	Output	29, 34
Burst	53	Overview.....	9
Caution symbol.....	4	Power on/off	
Cleaning the instrument	6	safety instruction	5
Coupling	31	Power supply operation.....	70
Declaration of conformity.....	80	Preset settings.....	33
Default settings	33	Rear panel diagram	13
Disposal		Service operation	
symbol	5	about disassembly	5
Disposal instructions.....	7	State display.....	27
DS2-FH1 installation	14	Sweep	50
Dual tracking.....	31	Sync Output.....	34
EN61010		Tracking	31
pollution degree.....	6	Turn the output on or off	29

USB configuration 17

Warning symbol 4